

University of California, Berkeley

Tolman Hall East

Building Emergency Plan

Date Revised: May 24, 2016

Date Submitted: May 24, 2016

Prepared By:

No Record

TABLE OF CONTENTS

I. BUILDING INFORMATION

1. Building Name
2. Building Coordinator Name
3. Alternate BC Name
4. Emergency Assembly Area (EAA) Location
5. Emergency Management Area (EMA) Number
6. EMA Location
7. Departments
8. Building Safety Committee
9. Emergency Staff
10. Audible and Visible Alarms
11. Potential Fire Hazards
12. Fire Prevention Procedures
13. Critical Operations Found in Building
14. Medical and Rescue Duties for Employees

II. IMPORTANT PHONE NUMBERS

1. Campus Telephone Numbers for Life-Threatening Emergencies
2. Telephone Numbers for Non-Life Threatening Emergencies
3. Where to Get Information During a Large-Scale Emergency
4. What to Do When You Hear Campus Warning Sirens

III. EMERGENCY PROCEDURES

1. Emergency Notification Procedures
2. Medical Emergency
3. Evacuation Procedures
4. Disability Emergency Evacuation Procedures
5. Fire Procedures
6. Earthquake Procedures
7. Demonstration / Civil Disturbance Procedures
8. Criminal or Violent Behavior
9. Explosion or Bomb Threat Procedures
10. Hazardous Materials Release Procedures
11. Utility Failure

12. Elevator Failure
13. Flooding, Plumbing or Steam Line Failure
14. Natural Gas Release or Leak
15. Ventilation Problem

IV. EMERGENCY PREPAREDNESS

1. Evacuation
2. Supplies
3. Training and Documentation
4. Drills
5. Securing Building Contents

V. APPENDICES

- A. Acronyms and Terms
- B. Evacuation Policy for People with Disabilities
- C. Emergency Preparedness Guidelines for People With Disabilities
- D. Campus Alerting and Warning System
- E. Building Evacuation Diagrams

BUILDING EMERGENCY PLAN

As a building occupant, it is your responsibility to be familiar with this plan. If you have questions, consult your Building Coordinator, Department Safety Coordinator, or Safety Committee representative. As you read this document, pay particular attention to:

- Evacuation routes, exit points, and the location of your Emergency Assembly Area
- When and how to evacuate the building
- Locations of emergency equipment, supplies, and materials, such as fire extinguishers, pull alarms, first aid kits, emergency eye wash stations, and emergency showers
- Proper procedures for notifying emergency responders about an emergency
- Your emergency responsibilities, if you are assigned any, such as being a roll taker or floor monitor
- Potential fire hazards in your building
- Potential exposure to hazardous materials or processes in and around your work area, and means of protecting yourself in the event of an emergency

I. BUILDING INFORMATION

1. Building Name: Tolman Hall, East Wing

2. Building Coordinator Name

Name: Cynthia ROBINSON

Campus Address: null

Phone No.: +1 510 643-6257

Fax No.: +1 510 643-8904

EMail: crobinson@berkeley.edu

3. Alternate BC Name

Name: Alejandro Luna

Campus Address: 34013

Phone: +1 510 643-0807

Fax No.: +1 510 642-2739

EMail: aluna@berkeley.edu

4. Emergency Assembly Area (EAA) Location

When a building evacuation is required, first floor occupants meet near the circle on the south side of the building. Second, third, fourth and fifth floor occupants evacuate to the to Chancellor&apos

5. Emergency Management Area (EMA) Number

5

6. EMA Location

Strawberry Creek

7. Departments

Department: UC Library

DSC Name: Cory Welch

Campus Address: null

Phone: +1 510 812-0209

Email: cwelch@berkeley.edu

Department: Research Enterprise Support Services

DSC Name: Thom OPAL

Campus Address: null

Phone: +1 510 666-3307

Email: opal@berkeley.edu

Department: School of Education

DSC Name: Cynthia ROBINSON

Campus Address: null

Phone: +1 510 643-6257

Email: crobinson@berkeley.edu

Department: Facilities Services

DSC Name: No Records

Campus Address:

Phone:

Email:

Department: IST/Technology Acquisition & Sales

DSC Name: Margaret CHESTER

Campus Address: 33959

Phone: +1 510 642-4422
Email: mchester@berkeley.edu

8. Building Safety Committee

Member: Zachariah Veley

Campus Address:

Phone: +1 510 643-7041

Department:

Member: Katherine S Suyeyasu

Campus Address:

Phone: +1 510 642-0889

Department: School of Education

Member: Lauren Mendoza

Campus Address:

Phone:

Department: School of Education

Member: Cynthia ROBINSON

Campus Address:

Phone: +1 510 643-6257

Department: School of Education

Member: Uilani HUNT

Campus Address: 37046

Phone: +1 510 664-9984

Department: School of Education

Member: Danica DuPaty

Campus Address:

Phone: +1 510 643-2496

Department: School of Education

Member: Kathryn Capps

Campus Address:

Phone: +1 510 642-4207

Department: School of Education

Member: Rosandrea GARCIA

Campus Address: 35641

Phone: +1 510 642-0138

Department: School of Education

Member: Billie Jo Conlee

Campus Address:

Phone: +1 510 642-0746

Department: School of Education

Member: Ann Foley

Campus Address: 37049

Phone: +1 510 642-0709

Department: School of Education

9. Emergency Staff

Roll Takers:

Name: Zachariah Veley

Campus Address:

Email: zveley@library.berkeley.edu

Phone: +1 510 643-7041

Department:

Name: Cynthia ROBINSON

Campus Address:

Email: crobinson@berkeley.edu

Phone: +1 510 643-6257

Department: School of Education

Name: Kathryn Capps

Campus Address:

Email: kate@berkeley.edu

Phone: +1 510 642-4207

Department: School of Education

Floor Monitors:

Name: Katherine S Suyeyasu
Campus Address:
Email: ksuyeyasu@berkeley.edu
Phone: +1 510 642-0889
Department: School of Education

Name: Lauren Mendoza
Campus Address:
Email: lmendoza@berkeley.edu
Phone:
Department: School of Education

Name: Uilani HUNT
Campus Address: 37046
Email: lanihunt@berkeley.edu
Phone: +1 510 664-9984
Department: School of Education

Name: Danica DuPaty
Campus Address:
Email: danicadupaty@berkeley.com
Phone: +1 510 643-2496
Department: School of Education

Name: Rosandrea GARCIA
Campus Address: 35641
Email: rosa@berkeley.edu
Phone: +1 510 642-0138
Department: School of Education

Name: Lydia Yoon
Campus Address:
Email: lyd@berkeley.edu
Phone: +1 510 664-4474
Department: School of Education

Name: Ann Foley

Campus Address: 37049
Email: afoley@berkeley.edu
Phone: +1 510 642-0709
Department: School of Education

10. Audible and Visible Alarms

Alarm Sound: Elevator Alarm Sound

Description: The elevator alarm is a bell and it is not very loud. It only sounds when a person inside the elevator presses the alarm button. Both elevators (1 & 2) are equipped with an emergency phone system that automatically calls the UC Police when the red button is pushed. When you hear the elevator alarm, call the University Police at 510-642-6760

Alarm Sound: Fire Alarm Sound

Description: The evacuation alarm is a loud, continuous horn that will sound at each alarm station throughout the building. Anytime the alarm sounds, leave the building immediately by the nearest designated route following evacuation procedures

11. Potential Fire Hazards

No Records

12. Fire Prevention Procedures

** NOTE: Custodial services in the Residential and Student Services Program (RSSP), as well as some other Auxiliary departments, are maintained by in-house service providers. If applicable, please see sections below for details.

** NOTE: In the Residential and Student Service Program (RSSP), as well as some other Auxiliary departments, fire alarm systems, fire extinguishers and fire sprinkler systems are maintained by in-house trades, in cooperation with the Campus Fire Marshal. If applicable, please see sections below for details.

To prevent a fire, this building maintains a good housekeeping policy by storing flammable and combustible materials in an approved manner and avoiding accumulation of flammable and combustible materials in work areas and exit hallways.

The BC works with the building owner or Campus Fire Prevention Division at EH&S to ensure that there is no excess accumulation of flammable and combustible materials in this building.

Custodial services are provided to this building by building owner or Physical Plant-

Campus Services (PP-CS) (see sec.II-2d).

A schedule of custodial services in this building may be obtained by contacting the custodial services provider. The BC also works with PP-CS (or building owner) to maintain fire extinguishers, fire alarm systems, and fire sprinkler systems in this building.

13. Critical Operations Found In Building

There are no critical operations in this building for which employees are required to remain in the building during an emergency.

There are no operations that should be checked immediately after an emergency.

14. Medical and Rescue Duties for Employees

No occupant has been assigned medical or rescue duties specific to emergency situations in this building. Employees may have volunteered and been trained for campus search and rescue or Disaster First Aid by OEP for campus disaster situations (e.g. a large earthquake). These volunteers will report to the specific department designated for field teams in a disaster.

II. IMPORTANT PHONE NUMBERS

1. Campus Telephone Numbers for Life-Threatening Emergencies

a. From any office or campus public phone:

911

b. From your cell phone:

(510)642-3333

2. Telephone Numbers for Non Life-Threatening Emergencies

Police Department Name: [UCPD]

Police Department Phone: [(510) 642-6760]

Fire Department Name: [Berkeley Fire Department]

Fire Department Phone: [(510) 528-5770]

EH&S

(510)642-3073

Physical Plant-Campus Services(PPCS)

(510)642-1032

Custodial Services

(510)642-6515

The Office of Emergency Preparedness(OEP)

(510)642-1258

Medical Facilities:

Facility Name: Alta Bates Hospital Emergency

Facility Street Address: 2450 Ashby Avenue

Facility Phone: (510) 204-1303

Description: Alta Bates Summit

Facility Name: Tang Center Occupational Health Clinic

Facility Street Address: 2222 Bancroft Way

Facility Phone: (510) 642-6891

Description: University Health Services

Facility Name: Tang Center Urgent Care
Facility Street Address: 2222 Bancroft Way
Facility Phone: (510) 642-3188
Description: University Health Services

3. Where to Get Information During a Large-Scale Emergency

Campus emergency information line
1-800-705-9998

Campus emergency web site
<http://emergency.berkeley.edu>

Campus radio station
KALX 90.7 FM

City of Berkeley emergency radio station
1610 AM

4. What to Do When You Hear Campus Warning Sirens

Sirens are tested at noon on the first Wednesday of each month. If you hear the sirens at any other time:

SHELTER: Go inside your office, a nearby building, or your car and shelter inside to avoid exposure.

SHUT: Shut doors and windows. Building ventilation systems should be shut off if possible.

LISTEN: Go to one of the information sources listed above for campus emergency information.

III. EMERGENCY PROCEDURES

1. Emergency Notification Procedures:

When you call 911 or any other emergency number to request emergency assistance, you will be connected to Police Dispatch. Call from a safe location, remain calm and be prepared to give the dispatcher as much information about the emergency as you can (what the emergency is, where it is, if there are injuries, how serious, etc.) The dispatcher will ask questions so do not hang up until you are told to do so. The dispatcher may also give you instructions.

2. Medical Emergency:

If you are injured or have a medical emergency in the workplace, call 911 immediately if you are able. If you are unable to use the phone, verbally call for help. Anyone who hears you should summon help by calling 911.

If you witness an injury or medical emergency in the workplace, immediately assist the injured if it is safe for you to do so. Then call 911 as soon as possible from a safe location. Become familiar with emergency notification procedures (III-1).

3. Evacuation Procedures:

A building occupant is required by law to evacuate the building when the fire alarm sounds. There may be instances where the building would be evacuated without a fire alarm sounding.

When evacuating your building or work area:

- Stay calm; do not rush or panic.
- Safely stop your work.
- If safe, gather your personal belongings; take prescription medications with you.
- If safe, close your office door and window, but do not lock them.
- Use the nearest safe stairs and proceed to the nearest exit. Do not use the elevator.
- Pay attention to emergency staff for additional evacuation instructions.
- Proceed to the designated EAA and report to your roll taker.
- Wait for instructions from emergency responders.
- Do not re-enter the building until the emergency responders instruct you.

Appendix E contains a complete set of evacuation diagrams for this building. Look for the appropriate evacuation diagram(s) for your floor showing the directions for evacuation to the building exits. After you exit your building, proceed to the EAA. Note that most building egresses are located on the first floor of a building.

4. Disability Emergency Evacuation Procedures:

- During an emergency evacuation, individuals with mobility impairments should relocate to the Designated Waiting Area.
- The Location of Designated Waiting Areas are shown on building evacuation floor plans posted near building elevators and most stairwells.
- Persons with disabilities should follow the instructions on signage at the Designated Waiting Areas.
 - If possible telephone rescue personnel, and inform them of location (if using a cell phone, call 642-3333. Otherwise, call 911).
- An emergency evacuation chair to assist in carrying a person with mobility impairment up or down stairs is available in a marked cabinet on the ground floor of buildings with two or more floors (above or below the ground floor of the building). Many persons with mobility impairments have a key to the cabinet. If a cabinet key is not available during emergency evacuation, the lock on the cabinet should be broken if necessary to access the evacuation chair inside.
- Instructions on how to use the emergency evacuation chair are posted on the inside of the cabinet door, and set out below. Photographs demonstrating evacuation chair use, as well as a demonstration video, are available online at [HTTP://ACCESS-GUIDE.BERKELEY.EDU/SAFETY-GUIDE/](http://ACCESS-GUIDE.BERKELEY.EDU/SAFETY-GUIDE/)
 - Step 1: Open folded chair (like opening a folded lawn chair).
 - Step 2: Make sure that latches at the rear of the chair are secure.
 - Step 3: Secure passenger in chair with seat belt.
 - Step 4: If person with disability cannot control movement of limbs (e.g., arms, legs,) then use straps to secure limbs to chair before moving person.
 - Step 5: When a person is being carried either up or down stairs, make sure the person being carried is always facing up (not down) the stairs.
 - Step 6: Once on the final level surface, set chair down and push chair out of building in a posture similar to pushing a wheelbarrow (the legs of the evacuation chair have wheels).

5. Fire Procedures:

A building occupant is required by law to evacuate the building when the fire alarm sounds.

- If you see a fire and the alarm is not sounding, immediately notify the fire department by pulling the hand pull at the alarm station. Call 911 from a safe location to provide details of the situation.
- If trained, able and safe (with a sure and safe exit), use a portable fire extinguisher to extinguish the fire. Evacuate if one extinguisher does not put out the fire.
- Otherwise, evacuate the building as soon as the alarm sounds and proceed to the EAA.
- On your way out, warn others.
- Use stairs only; do not use elevators.
- Move away from fire and smoke. Close doors and windows if time permits.

- Touch closed doors. Do not open them if they are hot.
- Enter the building only when instructed to do so by emergency responders.

6. Earthquake Procedures:

During an earthquake:

Inside the Building:

- Duck under the nearest sturdy object and hold onto it until the shaking stops. If you are not near a sturdy object, make yourself as small as possible and cover your head and neck.
- If you stand in a doorway, brace yourself against the frame and watch out for a swinging door or other obstruction.
- Avoid windows, filing cabinets, bookcases, and other heavy objects that could fall or shatter.
- Stay under cover until the shaking stops, then leave the building and go to the EAA or another designated location. Report to your roll taker.
- If safe, before evacuating, stabilize any laboratory procedure that could lead to further danger. (Example: turn off Bunsen burners or electrical equipment.)

Outside the Building:

- Move away from trees, signs, buildings, electrical poles and wires, fires, and smoke.
- Protect your head with your arms from falling debris.
- Proceed to the EAA or a pre-designated alternate assembly area. Report to your roll taker.
- Stay alert for further instructions.

7. Demonstration/ Civil Disturbance Procedures:

Most demonstrations are peaceful and if one is conducted near or in your building, carry on business as usual. Avoid provoking or obstructing demonstrators. Should a disturbance occur, call Police for assistance (sec. II).

If protestors enter your building, let them. Try to carry on business as usual. If the noise becomes too great, or the crowd too large, feel free to close and lock your office doors and/or windows - this is a departmental decision.

Do not close your building unless the Police advise you to. If it becomes necessary to evacuate, follow directions from Police. Proceed to the EAA and wait for additional instructions.

8. Criminal or Violent Behavior:

Assist in making your work location a safe place by being alert to suspicious situations or persons and reporting them as outlined below.

If you are the victim of, are involved in, or a witness to any violation of the law such as assault, robbery, theft, overt sexual behavior, etc. call Police (sec. II) as soon as possible. Follow

notification procedures (sec. III-1). If safe, wait for Police to provide them with more information.

9. Explosion or Bomb Threat Procedures:

A suspicious-looking box, package, object, or container in or near your work area may be a bomb or explosive material. Do not handle or touch the object. Move to a safe area and call the Police immediately. Use a telephone in a safe area. Do not operate any power switches, and do not activate the fire alarm.

If there is an explosion:

- Take cover under sturdy furniture, or leave the building if safe and directed to do so by emergency responders.
- Stay away from windows.
- Do not light matches.
- Move away from the hazard site to a safe location.
- If instructed to evacuate, use the stairs only; do not use the elevators (Sec. III-2).

If you receive a bomb threat (via the telephone):

- Stay calm and keep your voice calm.
- Pay close attention to details. Talk to the caller to obtain as much information as possible.
- Write down the date and time of the call.
- Take notes. Pay attention to details. Ask as many questions as possible:
 - When will it explode?
 - Where is it right now?
 - What does it look like?
 - What kind of bomb is it?
 - Where did you leave it?
 - Did you place the bomb?
 - Who is the target?
 - Why did you plant it?
 - What is your address?
 - What is your name?
- Listen to the caller's voice. See if you can identify
 - Speech patterns (accent, tone)
 - Emotional state (angry, agitated, calm, etc.)
 - Background noise (traffic, people talking and accents, music and type, etc.)
 - Age and gender
- Write down other data:
 - Date and time of call
 - How threat was received (letter, note, telephone)
- Call the Police (sec. II) and relay the information from the bomb threat telephone call or bomb threat letter. Follow the Police's instructions.
- Check your work area for unfamiliar items. Do not touch suspicious items; report them to the Police.
- If you are told by emergency responders to evacuate the building, see "Evacuation Procedures" above (sec. III-2):

10. Hazardous Materials Release Procedures:

If a hazardous material is released or spilled near you and you are not a user nor knowledgeable about hazardous materials, call Police immediately and move away from the release area (see II).

If you are a hazardous material user and you cause a release of a hazardous material, you should know the emergency procedures for cleaning up a hazardous spill. All hazardous materials users should be trained on proper use and storage of hazardous materials, including proper procedures for preventing spills and emergency procedures when a spill occurs. Training is available to all hazardous material users (see IV. 3, Training and Documentation). If you have not been trained and don't know what to do, leave the area and warn others. When you are at a safe location, call Police immediately (see II).

11. Utility Failure:

In the event of a major utility failure, notify PP-CS (or the building owner, if you are off-campus in a leased space). Evacuate the building if the fire alarm sounds and/or upon notification by Police. Do not panic; evacuate in an orderly manner, proceed to the EAA and wait for further instructions.

In laboratory buildings, fume hoods do not operate during a power outage and many laboratories should not be used until ventilation is properly restored. For more information, refer to the EH&S Fact Sheet #16, "Be Prepared for Power Failures."

12. Elevator Failure:

If you are trapped in an elevator, use the emergency telephone inside the elevator to call for assistance or press the elevator alarm inside the elevator to signal for help.

13. Flooding, Plumbing or Steam Line Failure:

If your building has a plumbing failure, a flood, or a steam line failure:

- Cease using electrical equipment.
- Evacuate the building if necessary and proceed to the EAA.
- Call PP-CS if necessary.

14. Natural Gas Release or Leak:

If you smell natural gas:

- Cease all operations immediately.
- Do not operate light switches.
- Evacuate as soon as possible.
- Call Police and PP-CS or your building owner/contact person for leased space.

15. Ventilation Problem:

If you smell odors coming from the ventilation system:

- Immediately notify PP-CS and EH&S if you are located on campus or the building owner/contact person if you are off-campus.
- If necessary, cease all operations immediately.
- If necessary, evacuate the building and proceed to the EAA.
- If smoke is present, pull the fire alarm, then call Police from a safe location.

IV. EMERGENCY PREPAREDNESS

1. Evacuation:

For a more efficient evacuation from your building, become familiar with the evacuation diagrams posted near stairs and elevators on your floor. Appendix E in this BEP also contains floor diagrams showing your evacuation routes and your building exits. Become familiar with them and practice the evacuation process to enable you to safely leave your building in a real emergency. Your DSC and BC are available to answer any relevant questions or concerns you may have (see Section 1 for contact information). EH&S (642-3073) and OEP (642-1258) are also available to help.

2. Supplies:

Be prepared for emergencies. One thing you can do is keep an emergency kit in your work area that is easy to carry when evacuating the building.

The following supplies are recommended for your personal kit:

- Drinking water (1 gallon a day; 3 days' supply recommended)
- Food (keep airtight in pest-proof packaging)
- Flashlight and extra batteries
- Utility knife
- First aid kit with special personal needs such as prescription medication and glasses
- Sturdy, comfortable shoes and clean socks
- Emergency blanket or a standard blanket
- Light sticks
- Heavy duty work gloves
- Cash (some in quarters)
- Sanitation needs (such as tissue paper, small bottle of bleach, plastic bags, plastic bucket)
- Duct tape and barrier tape
- Large sheets of paper, markers, pens and pencils
- Whistle
- Campus and area maps

Replace items when expired, or necessary.

3. Training and Documentation:

Law requires training on the BEP. The DSC is responsible for training the department employees on the BEP and keeping training records. It is the responsibility of the occupant to become familiar with the BEP, to know evacuation routes and assembly areas, and to attend training(s) given by the department on emergency preparedness and safety. As a supplement to the training, the BC posts information in the building for occupants and guests.

Other training recommended for building occupants includes CPR, first aid, and fire extinguisher training. An occupant interested in any safety training should see his/her DSC or

BC. Call OEP for more information on CPR and first aid training, and EH&S for fire extinguisher training.

Annual "Hazardous Materials Spill Response" training is required for any employee that handles hazardous materials. This training is available online at the UCB Learning Center through the Blu portal (<http://blu.berkeley.edu>). Employees who cannot access the Blu portal can complete the training at the workaround on the EH&S website (<http://ehs.berkeley.edu/trainnonemploy.html>).

4. Drills:

Building evacuation drills are optional for all campus buildings except residence halls. Consult your BC if you wish to have an evacuation or fire drill in your building. The BC is responsible for conducting the drill and documenting it. Obtain a copy of the documentation and submit it to your DSC. The campus Fire Prevention Division at EH&S can help in planning. Call EH&S for more information.

If you wish to become familiar with your evacuation routes, particularly in a large building, consult the evacuation diagrams on your floor and follow the routes of exit until you reach the EAA. You can also use the evacuation diagrams in Appendix E of this BEP. Should you experience difficulty locating your evacuation route, consult your DSC or BC. EH&S (642-3073) and OEP (642-1258) are also available to help resolve this issue.

5. Securing Building Contents:

Many earthquake-related injuries do not come from collapsing buildings, but from objects inside the building which fall on people, or from windows shattering and causing lacerations. Make sure that shelves, computers, wall hangings, and equipment are physically secured. In most cases, as a part of your department's General Safety Inspections required by the Injury and Illness Prevention Program, items listed below are checked. However, you may conduct your own inspection of your work area. If there are concerns after your self-inspection, contact your DSC or call EH&S or OEP.

The main things to look for are:

- Shelves or cabinets that are not bolted to the wall
- Computers or typewriters on desks
- Objects on shelves which may fall or turn into projectiles
- Freestanding objects that do not have a high enough base: height ratio to be "fall proof" (e.g., a filing cabinet over 4 feet tall)
- Desks or seating areas directly under plate glass windows
- Heavy hanging pictures, mirrors, or plants
- Cupboards or cabinets without secure "automatic" latches
- Objects on wheels which are not locked in one position (e.g., an audiovisual cart)
- Heavy items which are above head height.
- Doorways that might be blocked by falling objects

For more information about securing falling hazards, please contact your DSC, BC, or PP-CS.

V. APPENDICES

Appendix A: Acronyms and Terms

Acronym	Meaning
BC	Building Coordinator
BEP	Building Emergency Plan
DSC	Department Safety Coordinator
EAA	Emergency Assembly Area
EMA	Emergency Management Area
EH&S	Environment, Health & Safety
IIPP	Injury and Illness Prevention Program
OEP	Office of Emergency Preparedness
Term	Definition
Building Coordinator	A University employee who has a defined role in campus emergency/disaster preparedness: he or she prepares the BEP and serves as the communication liaison between campus service agencies and building occupants for specific circumstances enumerated in the BC position description.
Building Emergency Plan	A document which consists of emergency information and procedures, activities for preparing for emergencies, and roles and responsibilities of building occupants.
Building Safety Committee	A group usually composed of members of each department in the building, generally chaired by the BC, charged with building emergency preparedness and overseeing building safety concerns.
Department Safety Coordinator	A University employee who assists department management in coordinating, implementing, and documenting the department's safety program. This includes maintaining the department's IIPP, and ensuring department employees are trained on their BEP(s).
Department Safety Committee	A group composed of department representatives (preferably from each major unit in the department). If a department occupies different buildings, representatives from each building should be on the committee. The committee takes care of the department's health and safety issues and must meet quarterly as outlined in the campus IIPP.
EAA	A pre-designated safe location near a building where building occupants assemble and report to the roll taker(s) after evacuating the building.

EMA	EMAs are part of the overall campus disaster preparedness program activated and used by emergency responders in major disasters. The campus is divided into 18 EMAs (See the map on the inside back cover of the campus telephone book for a list and location of EMAs.) An EMA can be a section of campus, an off-campus area, or a satellite area. Each EMA has a designated location (signified by red dots and numbers on the campus map) that will be the site of an incident command post and focus of activity (e.g., dissemination of information, administration of first aid, etc.) in a major disaster.
Emer. Operations Center (EOC)	The headquarters for designated representatives of campus essential services, where campus response is coordinated and resources are allocated during a disaster.
Emergency Responder(s)	Trained personnel who provide assistance in an emergency. They are not building occupants and may be from the University Police, local fire departments, EH&S, PP-CS, etc. In critical situations they may take charge of the building and have full authority over activities in and around the building.
Floor Monitor	A building occupant assigned to assist with a building evacuation during an emergency by alerting other occupants on their way out of the building.
IIPP	A department's written program for identifying and addressing workplace hazards. A main component is an active department safety committee.
Roll Taker	A building occupant assigned to take roll call at the EAA after a building evacuation.

Appendix B: University of California, Berkeley Evacuation Policy for People with Disabilities

The following guidelines have been adopted by the Berkeley campus to assist in planning for the evacuation of people with physical disabilities.

IN ALL EMERGENCIES, AFTER AN EVACUATION HAS BEEN ORDERED:

- Evacuate people with disabilities if possible.
- Do not use elevators, unless authorized to do so by police or fire personnel. Elevators could fail during a fire or a major earthquake.
- If the situation is life threatening, call 911.
- Check on people with special needs during an evacuation. A "buddy system", where people with disabilities arrange for volunteers (co-workers/neighbors) to alert them and assist them in an emergency, is a good method.
- Attempt a rescue evacuation ONLY if you have had rescue training or the person is in immediate danger and cannot wait for professional assistance.
- Always ask someone with a disability how you can help BEFORE attempting any rescue technique or giving assistance. Ask how he or she can best be assisted or moved, and whether there are any special considerations or items that need to come with the person.
- Evacuation Chairs for use when evacuating a person with a mobility disability are stored on the ground floor of almost every building. Look in the main hallway corridors for the beige cabinet marked "Disability Evacuation Chair" -- instructions for use are posted on the inside of the cabinet's door.

RESPONSES TO EMERGENCIES:

BLINDNESS OR VISUAL IMPAIRMENT

Bomb Threat, Earthquake, Fire, Hazardous Materials Releases, and Power Outages:

- Give verbal instructions to advise about the safest route or direction using compass directions, estimated distances, and directional terms.
- Do not grasp a visually impaired person's arm. Ask if he or she would like to hold onto your arm as you exit, especially if there is debris or a crowd.
- Give other verbal instructions or information (i.e. elevators cannot be used).

DEAFNESS OR HEARING LOSS

Bomb Threat, Earthquake, Fire, Hazardous Materials Releases, and Power Outages:

- Get the attention of a person with a hearing disability by touch and eye contact. Clearly state the problem. Gestures and pointing are helpful, but be prepared to write a brief statement if the person does not seem to understand.
- Offer visual instructions to advise of safest route or direction by pointing toward exits or evacuation maps.

MOBILITY IMPAIRMENT

Bomb Threat, Earthquake, Fire, and Hazardous Materials Releases:

- It may be necessary to help clear the exit route of debris (if possible) so that the person with a disability can move out or to a Designated Waiting Area (or alternative safer area).

- If people with mobility impairments cannot exit, they should move to a Designated Waiting Area (DWA), whose location is shown on posted floor plans by the elevator. If unable to safely reach/remain at a DWA, at least move to a safer area, e.g.,
 - most enclosed stairwells
 - an office with the door shut which is a good distance from the hazard (and away from falling debris in the case of earthquakes)
- If you do not know the DWAs and/or safer areas in your building, call the campus Fire Prevention Division at 642-3073 for a building survey.
- Notify police or fire personnel immediately about any people remaining at a DWA or elsewhere in the building and their locations.
- Police or fire personnel will decide whether people are safe where they are and will evacuate them as necessary. The Fire Department may determine that it is safe to override the rule against using elevators.
- If people are in immediate danger and cannot be moved to a Designated Waiting Area (or alternative safer area) to wait for assistance, it may be necessary to evacuate them using an evacuation chair or a carry technique. Evacuation Chairs for use when evacuating a person with a mobility disability are stored on the ground floor of almost every building. Look in the main hallway corridors for the beige cabinet marked “Disability Evacuation Chair” -- instructions for use are posted on the inside of the cabinet’s door.

Power Outages:

- If an outage occurs during the day and people with disabilities choose to wait in the building for electricity to be restored, they can move near a window where there is natural light and access to a working telephone. During regular building hours, BCs should be notified so they can advise emergency personnel.
- If people would like to leave and an evacuation has been ordered, or if the outage occurs at night, call Police at 642-6760 from a campus telephone to request evacuation assistance from the Fire Department.
- Some multi-button campus telephones may not operate in a power outage, but single-line telephones and pay telephones are likely to be operating. As soon as information is available, the campus emergency information line (642-4335) will have a recorded message stating when power is likely to be restored.

EMERGENCY EVACUATION OF PEOPLE WITH DISABILITIES:

Evacuating a disabled or injured person yourself is the last resort. Consider your options and the risks of injuring yourself and others in an evacuation attempt. Do not make an emergency situation worse.

Evacuation is difficult and uncomfortable for both the rescuers and the people being assisted. Some people have conditions that can be aggravated or triggered if they are moved incorrectly. Remember that environmental conditions (smoke, debris, loss of electricity) will complicate evacuation efforts.

The following guidelines are general and may not apply in every circumstance:

- Occupants should be invited to volunteer ahead of time to assist disabled people in an emergency. If a volunteer is not available, designate someone to assist who is willing to accept the responsibility.
- Volunteers should obtain evacuation training for certain types of lifting techniques through the Disabled Students' Program (D.S.P.).
- Two or more trained volunteers, if available, should conduct the evacuation.
- Evacuation Chairs for use when evacuating a person with a mobility disability are stored on the ground floor of almost every building. Look in the main hallway corridors for the beige cabinet marked "Disability Evacuation Chair" -- instructions for use are posted on the inside of the cabinet's door.
- DO NOT evacuate disabled people in their wheelchairs. This is standard practice to ensure the safety of disabled people and volunteers. Wheelchairs will be evacuated later if possible.
- Always ASK disabled people how you can help BEFORE attempting any rescue technique or giving assistance. Ask how they can best be assisted or moved, and if there are any special considerations or items that need to come with them.
- Before attempting an evacuation, volunteers and the people being assisted should discuss how any lifting will be done and where they are going.
- Proper lifting techniques (e.g. bending the knees, keeping the back straight, holding the person close before lifting, and using leg muscles to lift) should be used to avoid injury to rescuers' backs. Ask permission of the evacuee if an evacuation chair or similar device is being considered as an aid in an evacuation. When using such devices, make sure the person is secured properly. Be careful on stairs and rest at landings if necessary.
- Certain lifts may need to be modified depending on the person's disabilities.

Summary:

Prepare occupants in your building ahead of time for emergency evacuations. Know your building occupants. Train staff, faculty, and students to be aware of the needs of people with disabilities and to know how to offer assistance. Hold evacuation drills in which occupants participate, and evaluate drills to identify areas that need improvement. Plans must cover regular working hours, after hours, and weekends. Everyone needs to take responsibility for preparing for emergencies. People with disabilities should consider what they would do and whether they need to take additional steps to prepare. "Emergency Guidelines for People with Disabilities" is available from your BC or DSC.

If you have questions about this campus policy or need additional information, contact one of the organizations below:

- Evacuation policies: OEP, 642-1258
- Student disability issues: Disabled Students' Program, 642-0518 (voice), 642-6376 (TTY /TDD)
- Fire regulations, safe areas: Campus Fire Prevention Division, EH&S, 642-3073

Prepared by OEP and EH&S April 2001 / Revised March 2009

Appendix C: Emergency Preparedness Guidelines for People With Disabilities

Follow the guidelines on the "Emergency Info" poster or in the Evacuation Policy for People with Disabilities. In particular:

- Make your environment earthquake and fire safe (do not place heavy objects above where you sit or sleep, bolt bookcases to the wall, make sure your exit route is clear).
- Keep sufficient emergency supplies to last three days (include food, water, prescription medicines and any other supplies you might need).
- Become familiar with alternate evacuation routes in buildings you use frequently.
- Learn where the evacuation chair cabinets and the Designated Waiting Areas are (and what may constitute an alternative safe area) in buildings you use frequently.

If the "Emergency Info" poster guidelines do not apply to you, develop other strategies for your protection. For example, if you use a wheelchair and cannot duck and cover under a table:

- Protect your head as much as possible.
- Move away from windows, filing cabinets, bookcases, light fixtures, and heavy objects that could shatter, fall, or tip over.
- Engage the electronic brake or wheel locks on your wheelchair.

Consider various disaster scenarios and decide ahead of time what you would do in different emergencies. For example, people with power wheelchairs should consider the following:

- In evacuations, it is standard practice to evacuate disabled people without their wheelchairs. Where should you be located while waiting for your wheelchair?
- Are there certain medications or support systems that you need?
- Do you have access to another wheelchair if yours cannot be evacuated?

Know your limitations and be aware of your needs in different emergencies.

If you need assistance, ask for it. People may not be aware of your circumstances or know how they can help.

Consider how people will give you emergency information and how you will communicate your needs if you have impaired speaking, hearing, or sight.

Consider arranging a buddy system with friends or colleagues so that someone will check with you, alert you as necessary, and see whether you need any assistance.

If you need to be evacuated, help yourself and rescuers by providing others with information about your needs and the best ways to assist you.

Developed by the Disabled Students' Program and OEP
Effective November 1993 / Revised March 2009

Appendix D: Campus Alerting and Warning System

The Alerting and Warning System (AWS) is a network of sirens and communication links that warn and inform the campus community of what to do in an emergency or disaster. This includes dangers resulting from natural or technical hazards such as chemical spills, flooding, fires, storms, power outages, transportation incidents, and other public safety incidents.

The campus has four hazard warning sirens strategically located to cover the main campus and adjacent campus facilities. The University of California Police Department activates these sirens. Depending on the incident, sirens and/or public address announcements may be transmitted over this system.

What do you do when you hear a warning siren?

- **SHELTER:** Go inside your office or residence, a nearby building, or your car and shelter inside to avoid exposure. If driving a car, safely pull over to the side of the road, turn off the engine and stay tuned.
- **SHUT:** Shut all doors and windows. Building managers should turn off ventilation systems, if feasible.
- **LISTEN:** Access one of the following sites to obtain campus emergency information, such as disaster type, evacuation routes, shelter and aid locations, special instructions, etc.
- **Emergency Information Line:** 1-800-705-9998. This out-of-area number allows recorded messages to be accessed by any standard, cell or pay phone, free of toll charges. Information about the emergency is recorded as an outgoing message, and is updated as the situation evolves.
- **Web Site:** <http://emergency.berkeley.edu>. This off-site alternate emergency web presence is reachable anytime, from anywhere. Like the 800 service, local area power failures or other crisis conditions will not affect the operation of this web site.
- **Radio Station:** KALX 90.7 FM. The campus radio station, broadcasting at 500 watts, will be utilized to disseminate emergency information during critical incidents and disasters. KALX normally broadcasts live 24 hours a day. KCBS (740 AM), KGO (810 AM), and KNBR (680 AM) also carry Bay Area emergency information.

DO NOT CALL 911 IF YOU HEAR A WARNING SIREN. ONLY CALL 911 IF YOU HAVE A LIFE-THREATENING EMERGENCY.

Since disasters are unpredictable, one must be prepared for an emergency whether at home, at work, at school, or in the car. Think about places where you spend your time and how you can best prepare for an emergency at any given location and time. It is wise to keep a battery operated AM/FM radio and extra sets of batteries at home, at work, and in your car.

Tolman Hall, Basement Evacuation Diagram

Emergency Telephone

Numbers:

9-911 from campus phones

911 from off-campus or
pay phones



You are here



Primary exit route



Secondary exit route



Fire extinguisher
or hose



Fire alarm



Elevator

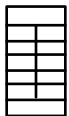

Stairs



Persons needing
assistance shall go
to the stairs enclosure
as indicated

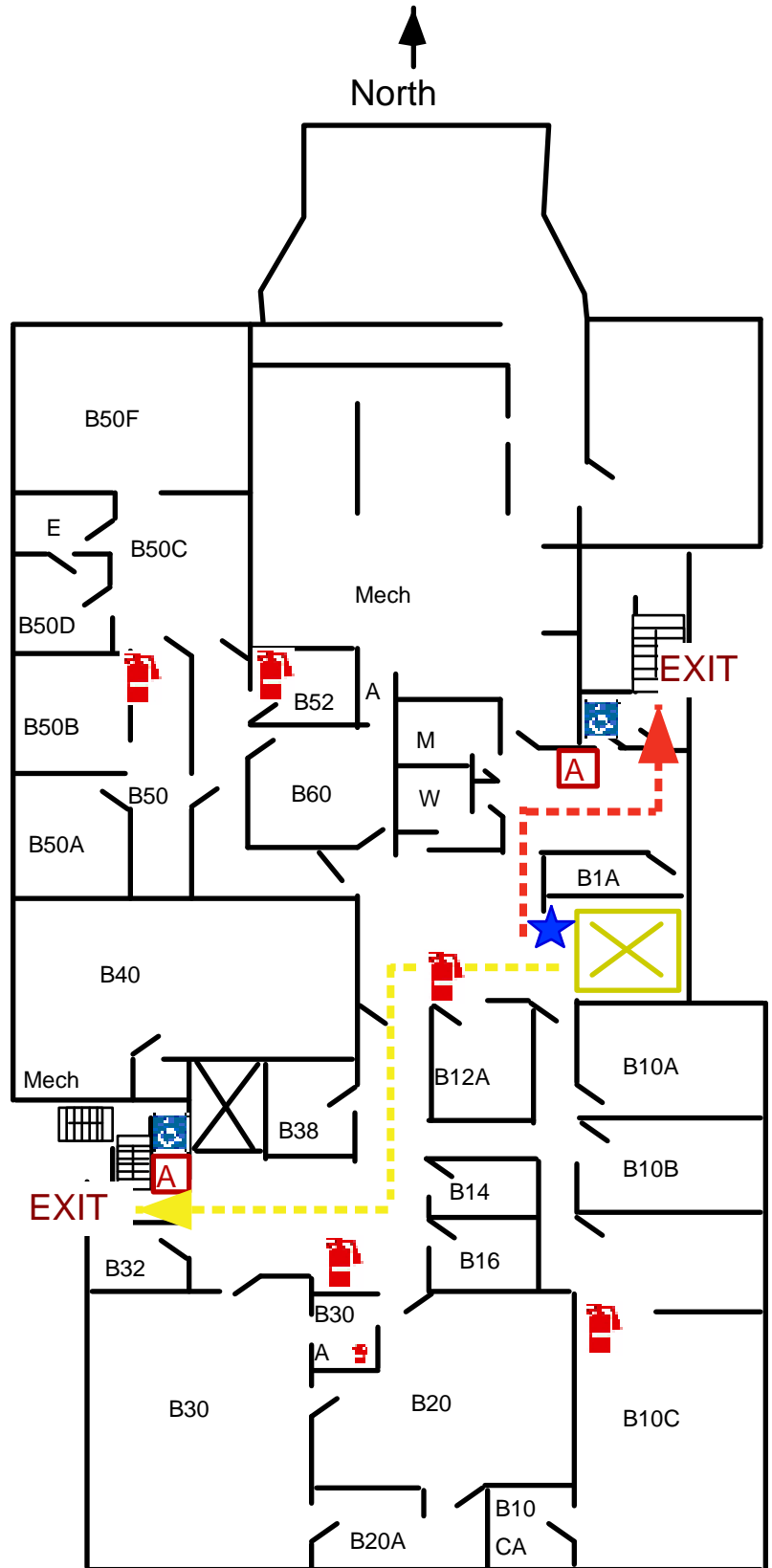

Tolman Hall, 1st Floor Evacuation Diagram

Emergency Telephone

Numbers:

9-911 from campus phones

911 from off-campus or
pay phones



You are here



Primary exit route



Secondary exit route



First aid kit



Fire extinguisher
or hose



Fire alarm

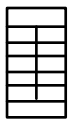

Stairs



In case of Emergency
do not use Elevator



Persons needing
assistance shall go
to the stairs enclosure
as indicated

South

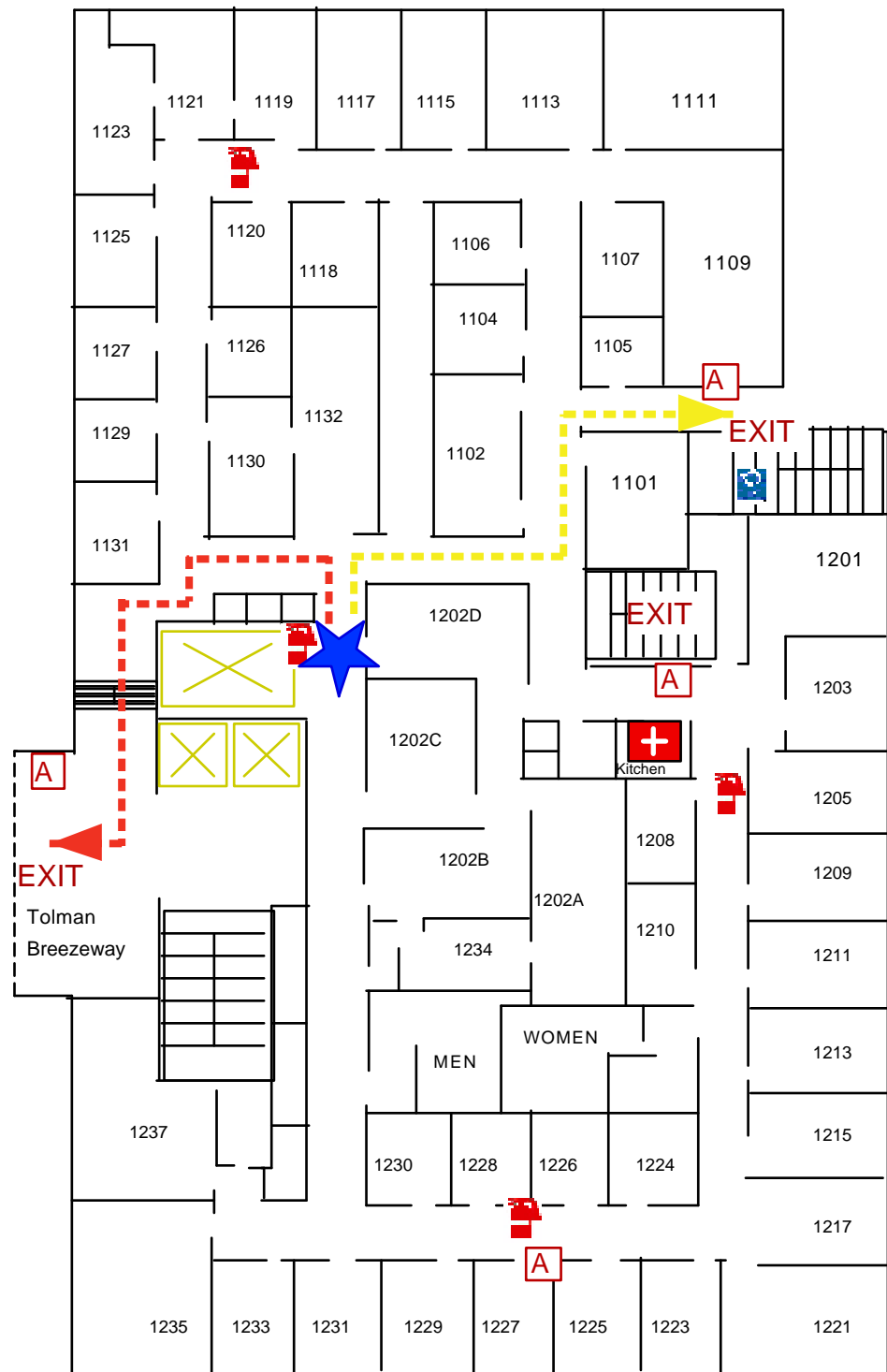
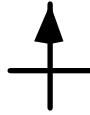

Tolman Hall, 2nd Floor Evacuation Diagram

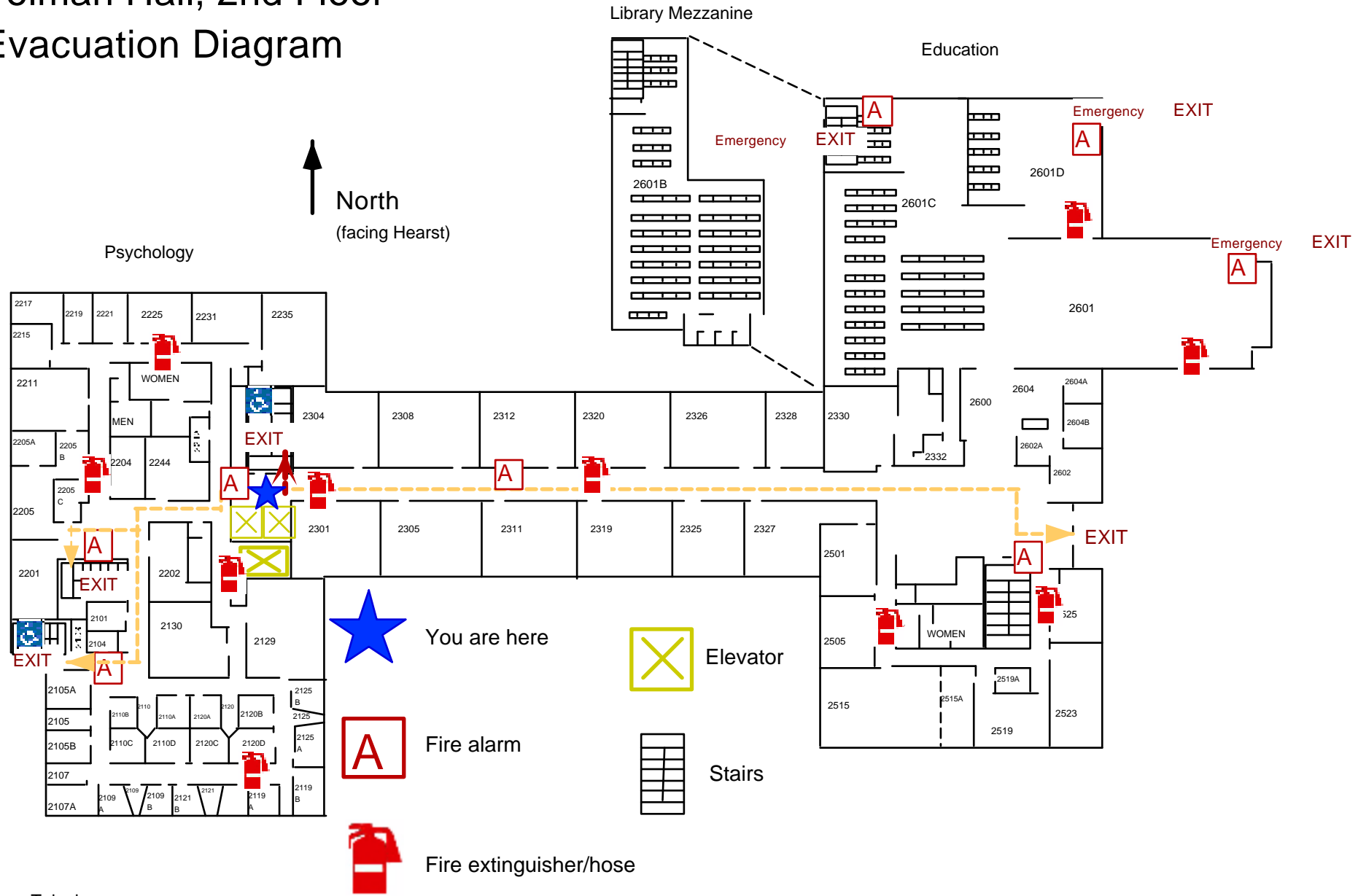

Emergency Telephone

Numbers:
9-911 from campus phones
911 from off-campus or
pay phones



Persons needing
assistance shall go
to the stairs enclosure
as indicated



Primary exit route



Secondary exit route



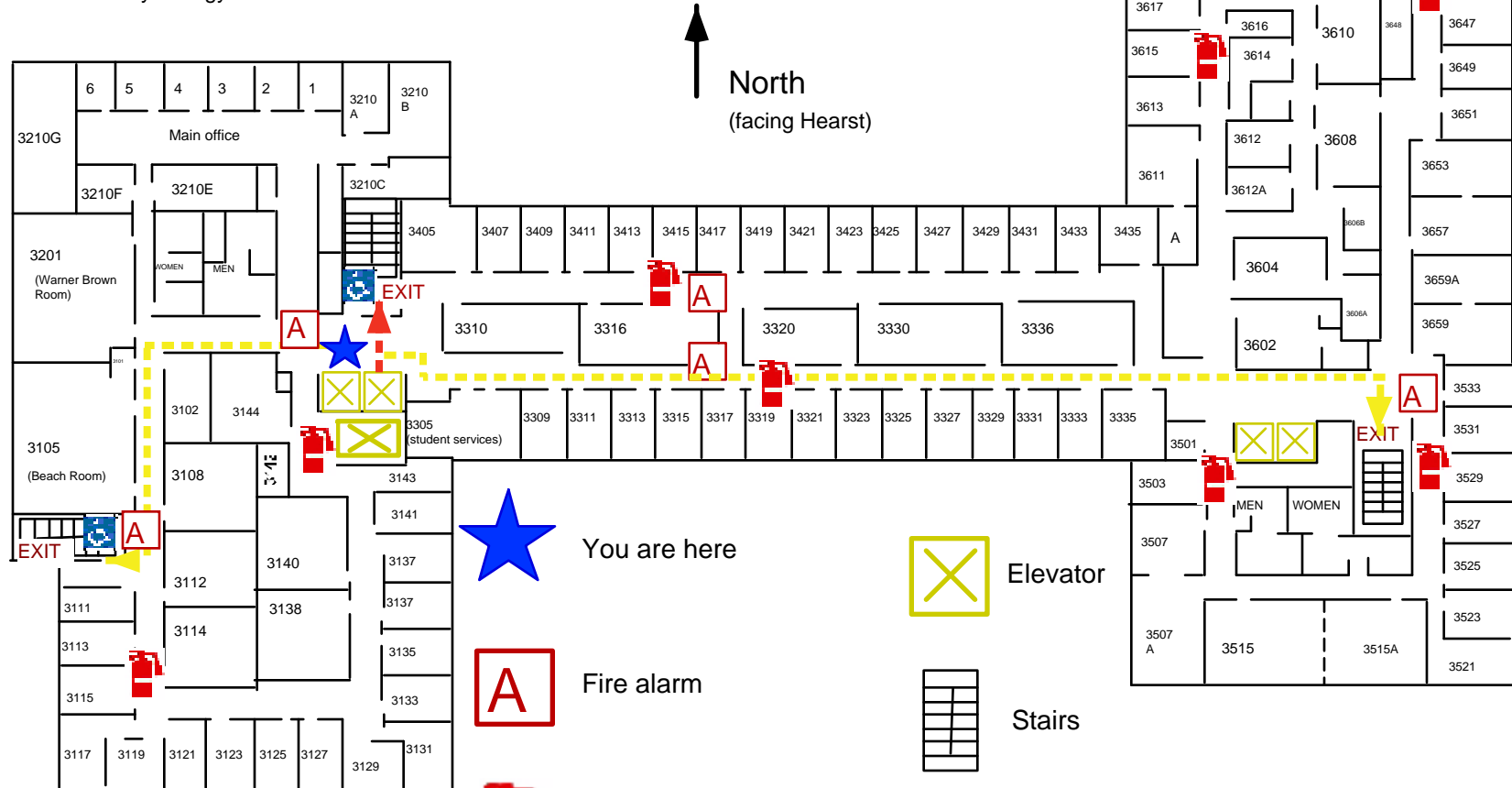

Tolman Hall, 3rd Floor Evacuation Diagram

Education

Psychology

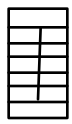

North
(facing Hearst)

-  You are here
-  Fire alarm
-  Fire extinguisher/hose
-  Persons needing assistance shall go to the stairs enclosure as indicated
-  Elevator
-  Stairs

Emergency Telephone
Numbers:
9-911 from campus phones
911 from off-campus or
pay phones

-  Primary exit route
-  Secondary exit route

Tolman Hall, 4th Floor Evacuation Diagram

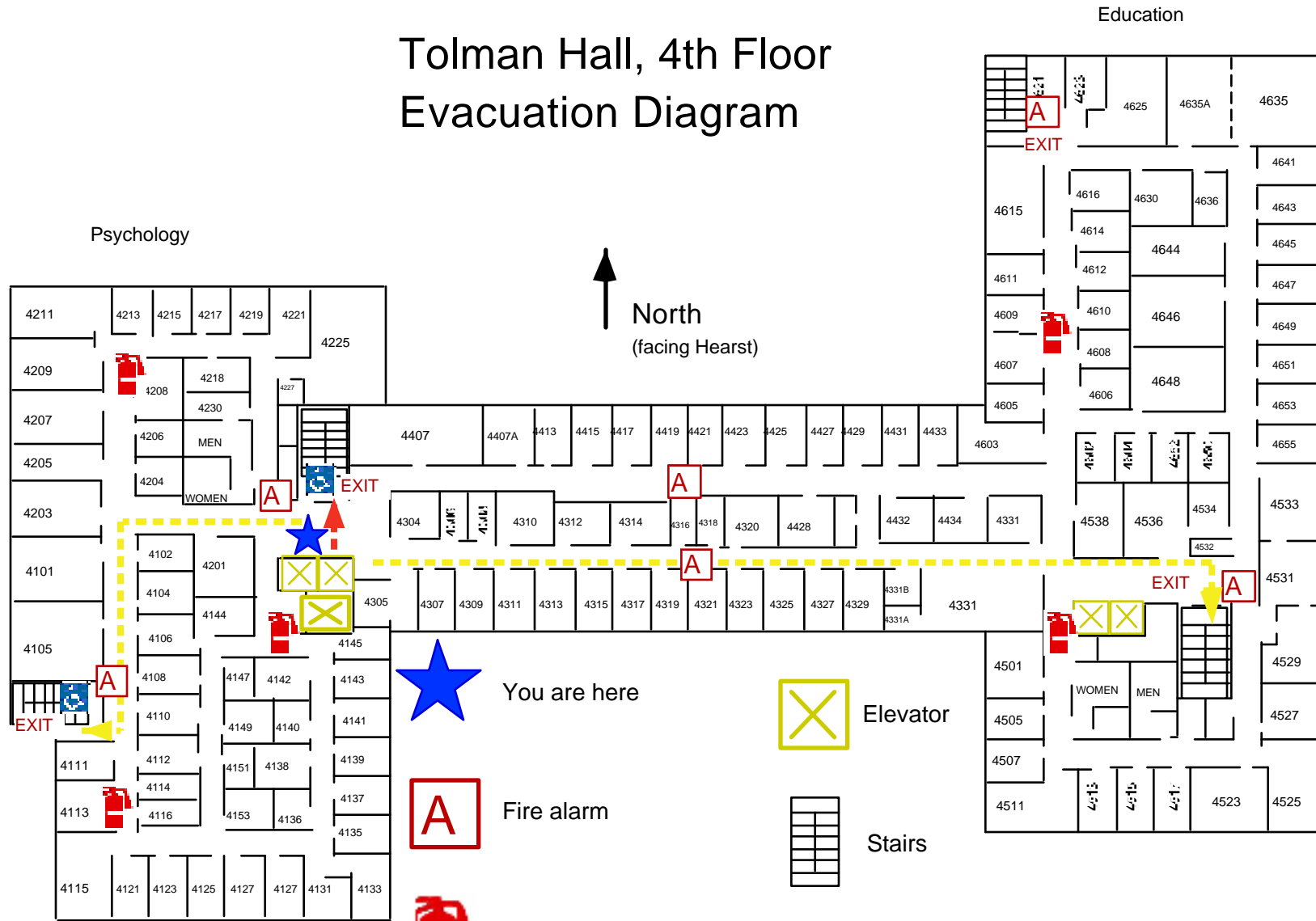

You are here



Fire alarm



Fire extinguisher/hose



Persons needing assistance shall go to the stairs enclosure as indicated



Elevator



Stairs



Primary exit route



Secondary exit route

Emergency Telephone

Numbers:

9-911 from campus phones

911 from off-campus or





pay phones

Tolman Hall, 5th Floor Evacuation Diagram

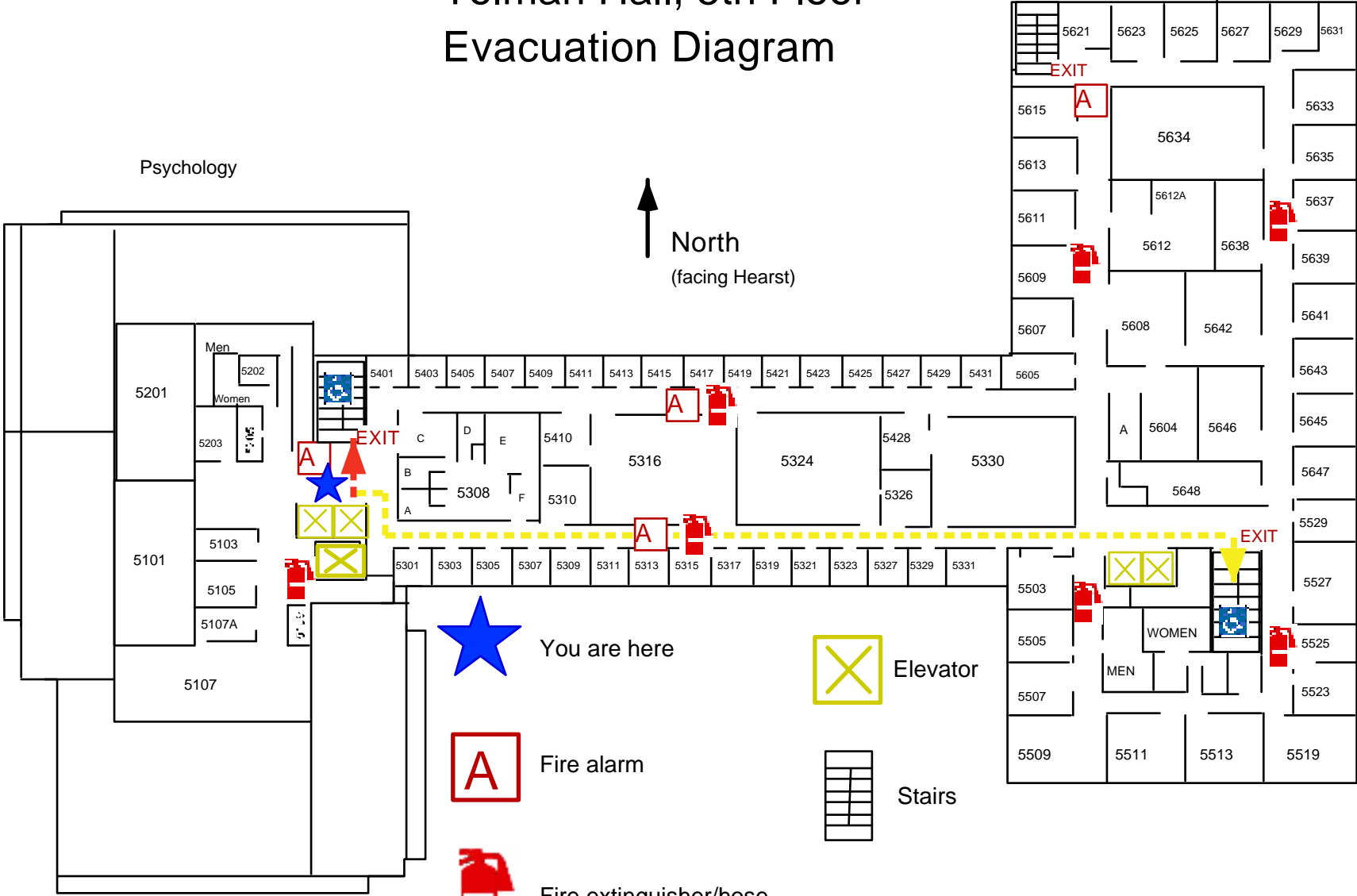
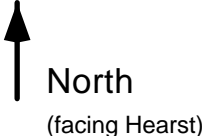
Education

Psychology

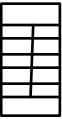

-  You are here
-  Fire alarm
-  Fire extinguisher/hose
-  Persons needing assistance shall go to the stairs enclosure as indicated
-  Elevator
-  Stairs

Emergency Telephone
Numbers:
9-911 from campus phones
911 from off-campus or
pay phones

-  Primary exit route
-  Secondary exit route